

SHADOWRUN

THIS OLD DRONE™

RANGE: 672 METERS
SPEED: 209.72 KPH
ARMED: AFFIRMATIVE
SIGNAL: ENCRYPTED
CAPACITY: UNKNOWN
CONFIG: CUSTOM

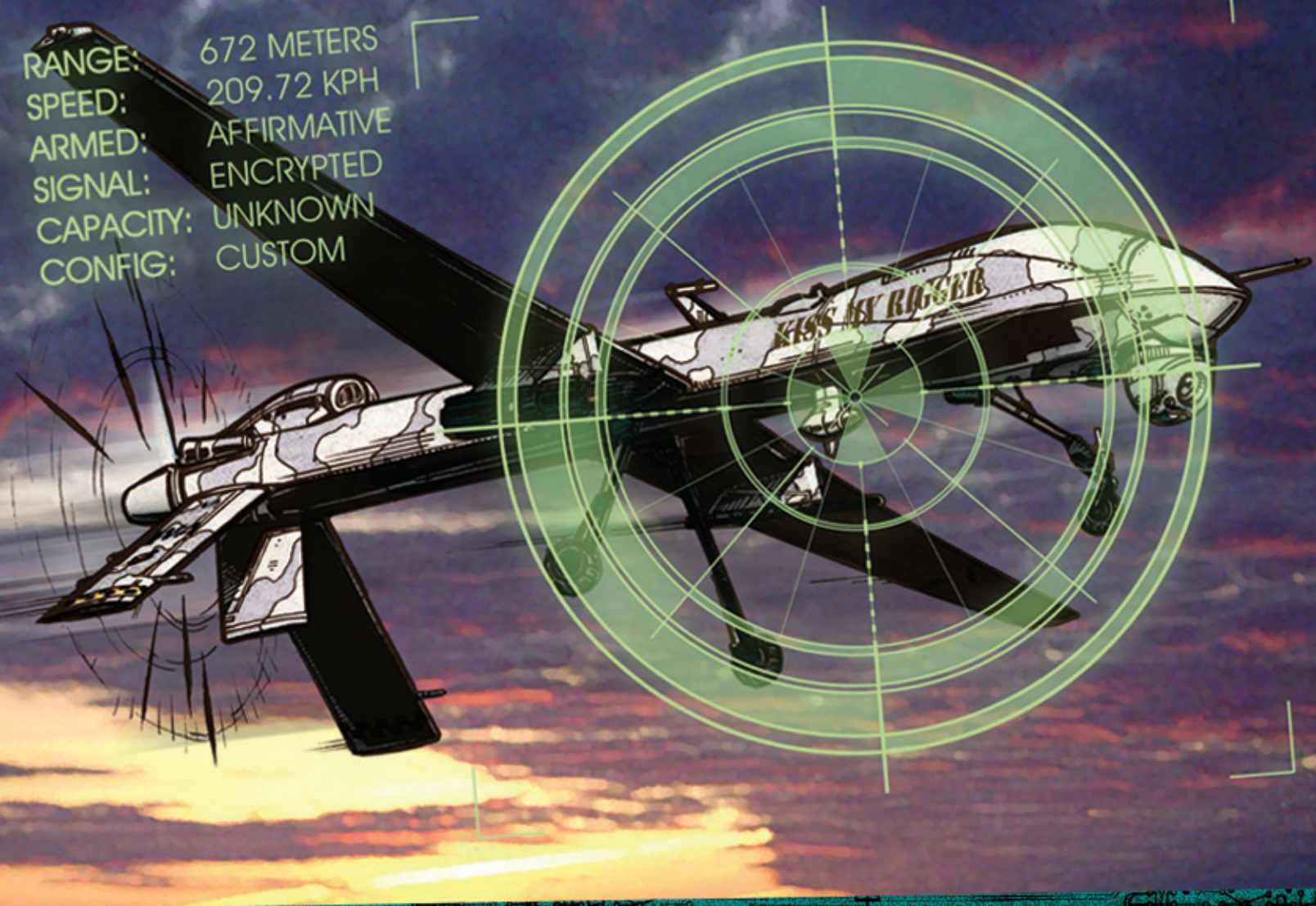

This Old Drone Credits

Writer & Project Developer

Peter M. Andrew, Jr.

Shadowrun Line Developer

Jason Hardy

Layout

Matt Heerdt

Art

Brent Evans, Chris Lewis

Rigger Black Book Illustrators

Tom Peters, Mike Nielsen, Jeff Laubenstein, Jim Nelson, Joel Biske, Dana Knutson, Denis Nelson

Rigger 3 Revised Illustrators:

Doug Anderson, Tom Baxa, Peter Bergting, Joel Biske, Doug Chaffee, Tom Fowler, Mike Jackson, Scott James, Jeff Laubenstein, John Paul Lona, Kevin Long, Larry MacDougal, Dave Martin, Jim Nelson, Mark Nelson, Zach Plucinski, Steve Prescott, Terese Nielsen, Shane White, Mark Zug

Copyright © 2010 Topps, Inc. All Rights Reserved. Shadowrun, This Old Drone and Matrix are registered trademarks and/or trademarks of Topps, Inc. in the United States and/or other countries. No part of this work may be reproduced, stored in a retrieval system, or transmitted in any form or by any means, without the prior permission in writing of the Copyright Owner, nor be otherwise circulated in any form other than that in which it is published. Catalyst Game Labs and the Catalyst Game Labs logo are trademarks of InMediaRes Productions, LLC.

Catalyst Game Labs,

an imprint of InMediaRes Productions, LLC

PMB 202 • 303 - 91st Ave. NE, G-701

Lake Stevens, WA 98258

Find us online

info@shadowrun4.com

(Shadowrun questions; please check the website FAQ first!)

<http://www.shadowrun4.com>

(official Shadowrun website)

<http://www.catalystgamelabs.com>

(Catalyst Game Labs website)

<http://www.catalystgamelabs.com/catalog>

(online Catalyst/Shadowrun store)

Connecting Jackpoint VPN ...
 ... Matrix Access ID Spoofed.
 ... Encryption Keys Generated.
 ... Connected to Onion Routers.
 > Login

 > Enter Passcode

 ... Biometric Scan Confirmed.
 Connected to <ERROR: NODE UNKNOWN>
"Sometimes it's better to let a little friend do the work."

JackPoint Stats

28 users currently active in the network

Latest News
 The latest patch of the p2p MoSoSo Gamma is available for download. Remember to send any bug reports to me. -Fastjack

Personal Alerts
 * An optional firmware update to your Ichi Clip wireless modem is now available.
 * You have 0 new private messages.
 * You have 97 new responses to your Jackpoint posts
 * Drone Alpha Pi 3 is requesting new instructions.

First Degree
 * Aufheben is online and in your area.

Your Current Rep Score: -729
 (3% Positive)

Current Time: July 30, 2072, 1815

- PREFERENCES
- FEEDS
- TASKS
- LINKS
- HISTORY

Welcome back to JackPoint, omae; your last connection was severed: 1 day, 3 hours, 38 seconds ago



Today's Heads Up

* Ever want to know what the local corps use to keep you out? Or are you looking for a surveillance tool so common that it slips under everyone's notice? Ever wanted to know what early drones looked like, and where you might be able to find one? I managed to find an academic resource that covers it.

Incoming

*Want to know what the big boys play with? Catch the next download from unusual suspects and stay ahead of the curve. [Tag: [Mil Spec Tech](#)]
 *Need something somewhere fast and Wuxing Express is not an option? Who are you going to call? [Tag: [Border Runners](#)]

Top News Items

*Knight Errant arrests two "Matrix Terrorists" near the Aztechnology Pyramid in Seattle. Reports do not mention any gear being carried by the suspects, sparking a wave of technomage paranoia. [Link](#)
 *A registered security Yellowjacket Helicopter crashes in Redmond; authorities are investigating the incident. [Link](#)
 *Children are caught racing micro-skimmer drones through the Tacoma Mall; Metroplex fines parents. [Link](#)

- CHAT
- MESSAGES
- FILES
- POSTS
- NEXUS
- SEARCH

Active

ComStar Firewall

Active

Jack-in-the-Box Antivirus

Active

SpamWitch Filter

On/Receiving

Commcode

Excellent

Signal

Active

Hidden Mode

Local Map

THIS OLD DRONE

Invited Guests
 x
 x

Posts/Files tagged with "Drone":
 * x
 * x
 * x
 * x
 * x

* x
 * x
 * x
[\[More\]](#)

CONTINUE
 ADVANCED SEARCH

SAVE

DULLING THE BLEEDING EDGE BY TURBO BUNNY

We all know that there's not much better in life than having the newest, shiniest gear on the block. We also know that the only people who can afford new, bleeding-edge gear before each run are super spies and kids who've got parents in high-level boardrooms. The rest of us have to make our tech last longer than a few months—or a few years. It doesn't take a whole lot of skill to squeeze some usefulness out of tech that's only a generation or two old; the real artists are the guys who can take something obsolete and make it sing, the ones who can go to a junkyard, find some scraps, and make it into something that may be clumsy but can get the job done. I came across this rundown recently and thought you all would be interested—it talks about some older drones that are still seeing life out there. You might run into one, or maybe one of them will be a cheap solution for you when you're in a budget-minded mood.

ARES SENTINEL "P" SERIES DRONE (SMALL DRONE)

This drone was the first commercially successful version of the now-ubiquitous fixed-path drone used by Ares' Sentinel security system to reduce operation costs. The drone is mounted on a rail system within (or around) a facility. It is not normally wireless capable, so it sends and receives data through a connection build into its motive system. It was originally constructed with a mini-turret and weapon mount, although some secondhand owners have modified them for less offensive duties.

Std. Upgrades: Obsolescent, Track Propulsion, Weapon Mount (Turret, Visible)

- These babies come with a critical weakness—once you own the controlling system, you own the drones. The guards can't regain control of them without rebooting the system. It's the easy way to cover your team's hoop.
- Glitch
- Unless there is a manual failsafe to shut down power to the rail. Not that I have heard it done in practice.
- Clockwork
- They exist; you don't hear much about them because employers don't want to provide their employees with access to these failsafes, because they don't trust them enough not to abuse it.
- DangerSensei

The Sixth World contains many different levels of development, and not all of them are bleeding edge or state of the art. The upgrades listed below are intended to simulate the challenges of utilizing older technology in Shadowrun.

VEHICLE TRAIT (UPGRADE):

Obsolescent: The vehicle uses an older generation of software, hardware or a combination of the two, resulting in less-sophisticated computing capabilities. The vehicle's device rating (p. 222, *SR4A*) is one less than what a comparable modern device's rating would be (to a minimum of 1); e.g., a drone with the obsolescent trait would have a rating of 2 rather than 3.

Obsolete: The vehicle uses a very old version of control software (or maybe even none at all), rendering it incompatible with current remote control rigs and AR technology. It may be considered a traffic hazard or be illegal to operate in certain jurisdictions. The vehicle does not possess the Rigger Adaptation Trait as standard. The vehicle's device rating (p. 222, *SR4A*) is three less than a comparable modern device's would be (to a minimum of 1), e.g., An M1A2 tank would have a device rating of 2, rather than the normal rating of 5 for military equipment.

Urgent Message...



THIS OLD DRONE

Sentinel "P" Series

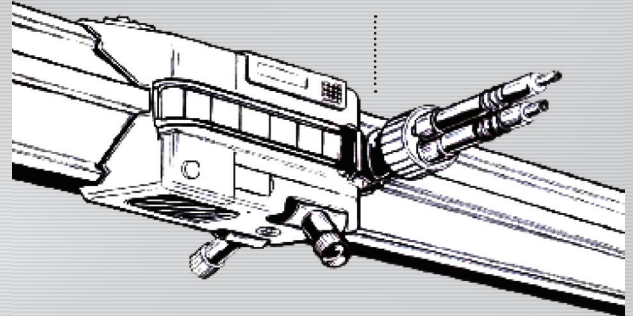

DRONES

Drones	Handling	Accel	Speed	Pilot	Body	Armor	Sensor	Avail	Cost
Ares Sentinel "P" Series	0	1/2	30	2	2	5	2	4R	1,900¥



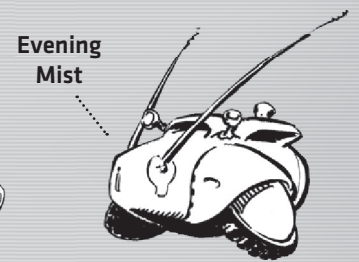
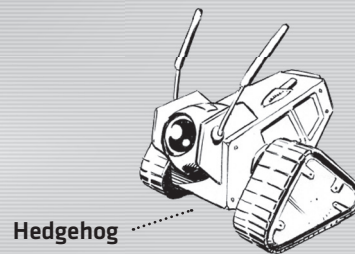
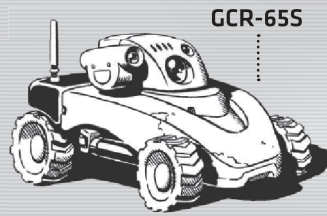
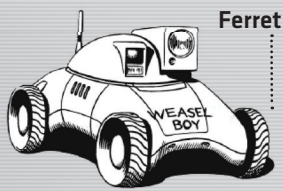

DRONES

FERRET RPD-V1 PERIMETER DRONE (MINI-DRONE)

This is an older model of the common Ferret, a wheeled perimeter defense drone. It does not carry weapons in its normal configuration, but functions as a sensor platform to provide more traditional security teams with better situational awareness. The market for various Ferret parts is projected to be stable for the foreseeable future.

Std. Upgrades: Obsolescent, Searchlight

- I still have three of these things in my spare parts bin. They're always fun to play with when there is a mod you want to test.
- Turbo Bunny
- They are still common in Japan. They tend to get underfoot, like insects.
- Baka Dabora
- Not all insects can be safely stepped on
- Man-of-Many-Names
- These are common on the shadow market as well, thanks mainly to a parts supplier in the Cantonese Confederation. They might also be the manufacturer of a few that fell off the back of a truck recently.
- Am-Mut

AZTECHNOLOGY GCR-65S (MINI-DRONE)

This drone serves a dual purpose for its owners. It's a fairly decent scout drone, and it's capable of designating targets for guided munitions, making it a fairly low cost, expendable addition to any mercenary unit. The drone's speed has also made it popular on the NASDRONE circuit, as it is easily modifiable for the more challenging courses, and repair parts are inexpensive.

Std. Upgrades: Obsolescent, Tacnet Software Rtg.1, Laser Designator Rtg. 2

- A good addition to any unit that has access to artillery support. A little dated perhaps, but a good rear guard unit when hidden in rough terrain. The opponent never knows where they are hiding, and they are cheap enough to be left behind.
- Black Mamba

- I like having a reliable way to take out a high-value asset without risking anyone in my unit.
- Picador

AZTECHNOLOGY HEDGEHOG SIGNAL INTERCEPTOR (SMALL DRONE)

The Aztechnology Hedgehog is an adaptation of the ubiquitous Crawler that has been extensively modified for electronic warfare. The unit was primarily manufactured for military support use but has found a new market in the shadows. It is capable of intercepting most electronic signals and utilizing simple decryption techniques to assist its rigger. Considered largely outdated in the new wireless world, it continues to be used by those organizations and individuals that can manage to patch its decryption routines enough to be effective.

Std. Upgrades: Obsolescent, Decrypt, Rtg. 3, Scan, Rtg. 3, Technical Autosoft: Electronic Warfare, Rtg. 2, and Walker Mode

- These were favorites until Crash 2.0, but with the proliferation of smaller drones, those that need to listen in on other people's conversations have smaller options.
- Fianchetto

RENRAKU EVENING MIST (MINI-DRONE)

This early model distraction drone has been used the world over. It provides a simple smoke screen to protect its designated location from unwanted observation. Renraku continues to produce the drone in moderate numbers, primarily to assist live performances with their special effects capabilities.

Std. Upgrades: Obsolescent, Smoke Projector (standard)

- A simple little device, I prefer the Lone Star iBall, but this one still works. I would recommend making sure that there's no way to connect this drone back to you; once your work is done, these things tend to be left behind.
- Clockwork
- I used to keep one just off stage for the occasional effect; unfortunately someone managed to hack it once during a performance. Not my best show.
- Kat o' Nine Tails

Drones	Handling	Accel	Speed	Pilot	Body	Armor	Sensor	Avail	Cost
Ferret V1	0	1/2	30	3	1	1	3	6	2,000¥
Aztechnology GCR-65S	0	1/3	60	2	1	0	2	6R	3,500¥
Aztechnology Hedgehog	0	1/4	15	3	2	0	2	5R	3,400¥
Renraku Evening Mist	+1	1/3	50	2	2	0	1	4	1,500¥



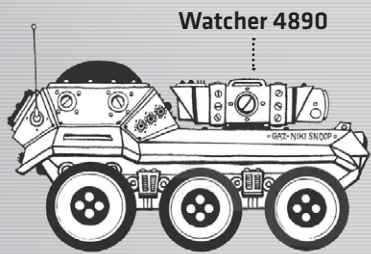

Watcher 4890

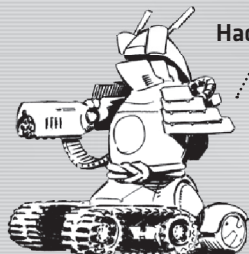

Hachiman

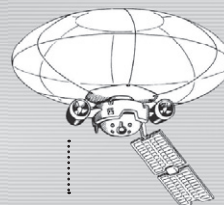

LDS-23/LDS-41

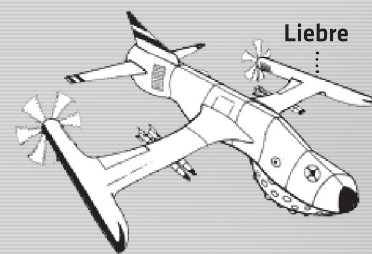

Liebre

DRONES

YAMATETSU WATCHER 4890 (SMALL DRONE)

The Watcher is a simple security drone that is often tasked with observation in wilderness areas. It has large balloon tires that make it capable of both high speeds and traversing rough terrain, although doing both at the same time can result in loss of control. Currently, some operators use it as a cheap version of the Ferret.

Std. Upgrades: Obsolescent, Improved Sensor Array

- A good snoop to run through lightly forested terrain, but despite claims to the contrary, it doesn't handle inclines very well.
- Picador
- The expanded sensor bay is nice; if you pick the right add-ons, it can be even more effective than a current generation Ferret.
- Clockwork
- If you use this things with its outdated operating system, you'll lucky if the local gangers aren't pirating the feed to protect their drug supply.
- Hannibelle

MCT HACHIMAN (MEDIUM DRONE)

This drone was originally intended for MCT's Zero Zones and high-threat areas, as it uses what were once considered advanced targeting techniques. The crawler is now used to protect lesser facilities, or is sometimes used by freelance operatives who need some extra firepower. Its unique appearance is no less terrifying to its foes than it was nearly ten years ago.

Std. Upgrades: Obsolescent, Spotlight, Reinforced Weapon Mount (remote, turret, external), Targetsoft 1

- These are still pretty rare on the shadow markets; it seems that Mitsuhamma doesn't like the idea of them getting into our hands.
- Am-Mut
- Hell, I'm not too fond of the idea of these becoming common. They have the ability to take out an entire team. Sure, it's nice for my rigger to have, but not for the rigger I'm going up against.
- Haze

AERODESIGN SYSTEMS CONDOR SERIES (LDS-23 AND LDS-41) (LARGE DRONE)

These drone models helped Aerodesign dominate the mini-blimp market for decades. The original LDS-23 is being manufactured by several knock-off manufacturers in the Canton Confederation, and the LDS-41 is still produced by its original manufacturer as a catalog-order item. The sun cell technology has been improved in efficiency since its original introduction, but the drone's other features have become dated.

Std. Upgrade: Obsolescent, SunCell, Lighter Than Air (LTA)

- The '23 is common enough—and goes off course enough—that most merchant vessels hardly notice them when they drift overhead. As the secret is, their course isn't always as random as the observers believe.
- Kane

AZTECHNOLOGY LIEBRE SURVEILLANCE/PURSUIT RPV (LARGE DRONE)

This drone was considered a cutting-edge component of Aztlan's military might until the recent Ghost Cartel incident proved that it had fallen behind the times. Although it is heavily armed for a surveillance drone, it does not possess the electronics or stealth capabilities that typify the current generation.

Std. Upgrades: Obsolescent, Weapon Mount (external, fixed, remote), Reinforced Weapon Mount (external, fixed, remote)

- AZT still uses a lot of them, and it's going to take a while for them to be fully replaced.
- Hard Exit
- They're still good enough to catch most smugglers that come in their sensor range.
- Traveler Jones
- Do you know this from personal experience?
- Cosmo
- I said "most."
- Traveler Jones

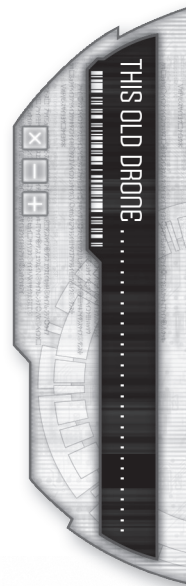

Drones	Handling	Accel	Speed	Pilot	Body	Armor	Sensor	Avail	Cost
Yamatetsu Watcher 4890	-1	1/2	75	1	2	0	2	6	1,350¥
MCT Hachiman	-1	1/3	30	2	4	8	2	8F	8,500¥
LDS-23	-4	1/2	60	1	3	1	2	4	5,000¥
LDS-41	-3	1/2	75	3	4	5	2	4	7,500¥
Liebre	-1	1/4	1,620	4	4	4	3	16F	19,500¥



Wandjina

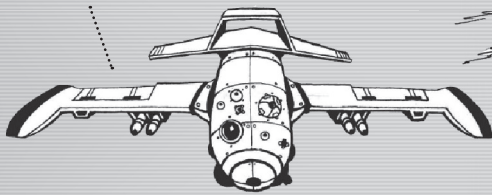

Finsceal

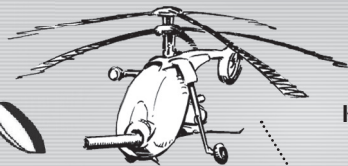

Kestrel

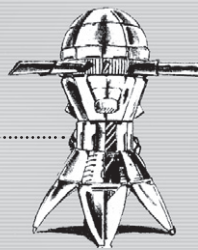

Courier

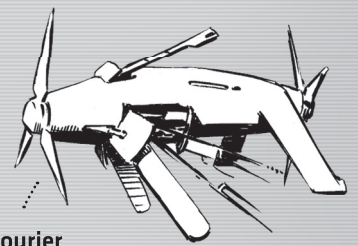

DRONES

CAS WANDJINA (LARGE DRONE)

This combat drone was one of the principal weapon platforms of the Confederate American States. It's still used in Australia, and some higher flight-hour models are now appearing on the secondary market. This series of drones may no longer be state of the art, but they provide a well-armed delivery platform nonetheless.

Std. Upgrades: Obsolescent, Weapon Mount (external, fixed, remote), Reinforced Weapon Mount (external, fixed, remote)

- The CAS still uses these—they're primarily in the hands of mercs or training units. They are considered good for trainees, as the armor protects the electronics from the inevitable rough landings.
- Hard Exit
- Why does this whole thing sound like as much like a sales brochure as a historical treatise?
- Netcat
- Who do you think paid to get this information together?
- Mr. Bonds

EIRRANN-TIR FINSCEAL (MEDIUM DRONE)

This airborne drone has been used in several engagements along Tír Tairngire's borders during the past seven years. Their appearance makes experienced smugglers lean on their throttles and prepare their countermeasures, as it often means a strike will be inbound shortly. This designation platform may be old, but it is cheap, effective, and frequently flies in pairs.

Std. Upgrades: Obsolescent, Target Designator, Rtg. 3 (microwave and infrared), Improved Takeoff and Landing 2

- The Tír doesn't always launch an immediate strike against smugglers. Sometimes they hang back and try to trace where they go.
- Traveler Jones
- It doesn't always take violence to get the desired result; sometimes the threat is enough.
- DangerSensei
- With most of group we have around here, trust me—it takes actual violence.
- Butch

LOCKHEED KESTREL (SMALL DRONE)

This lightweight roto-drone was originally used by the big players to monitor weak spots in security perimeters, but its limited payload capability does not give it many options to respond to potential breaches. The low cost ensures that it remains a popular option for those users that desire a disposable element to their surveillance team.

Std. Upgrades: Obsolescent, Clearsight 1 autosoft, Improved Takeoff and Landing 2

- These became less popular once the corporations realized that they could win the PR flap that comes with occasional casualties.
- DangerSensei
- Actually, in the case of Ares and other corporations with security subsidiaries, they can turn liquidating "terrorists" into a profit-making advertising campaign.
- Dr. Spin
- Always nice to know the different ways corps can turn death into profit on a whim.
- Snopes

FED-BOEING COURIER (MEDIUM DRONE)

This propeller-powered drone provides a smaller alternative to the GTS Tower, and it preceded that drone into production. The Courier has been used for the past five years as a rapid responder to communications outages for both private and public networks. It is still being used in that role by the remaining public utilities in UCAS, as its low price fits their limited capital budgets.

Std. Upgrades: Obsolescent, Retrans Unit (Signal 6)

- We recently used a couple of these to support an op in Africa. They're a little slower than we would have liked, but comms stayed up the entire time.
- Picador
- You must have been working against amateurs then; Couriers have a hole in their firewall a mile wide.
- Pistons

Drones	Handling	Accel	Speed	Pilot	Body	Armor	Sensor	Avail	Cost
CAS Wandjina	+1	2/5	500	2	4	8	3	12F	12,500¥
Eirrann-Tir Finsceal	0	1/3	105	2	3	1	3	9	5,500¥
Lockheed Kestrel	+1	1/3	70	2	2	1	2	8	1,900¥
Fed-Boeing Courier	0	1/3	105	2	3	0	2	6	6,000¥



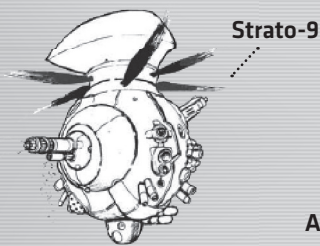

Strato-9

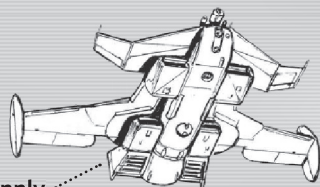

Air-Supply

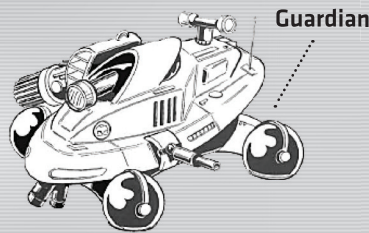

Guardian

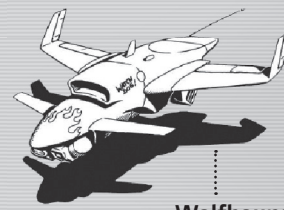

Wolfhound

DRONES

LONE STAR STRATO-9 (MEDIUM DRONE)

This early law enforcement drone has largely been replaced by more modern units in Lone Star service, although some lesser security agencies have purchased the old drones, helping low-level production continue through the current day. The Strato-9 remains popular due to its combination of a machine-gun mount and helicopter style movement system.

Std. Upgrades: Obsolescent, ECM 2, Reinforced Weapon Mount (external, flexible, remote), Improved Takeoff and Landing 2

- The Lone Star ideal, of course, is to do as much law enforcement as possible through mobile guns. They tend to think other techniques and approaches are wastes of time, unnecessarily dainty, or both.
- Snopes
- Remember: <BLAM!> <BLAM!> halt <BLAM!> is Lone Star's training manual.
- 2XL

ARES AIR-SUPPLY (LARGE DRONE)

The Ares Air-Supply drone is capable of lifting supplies for a team on the move. Its early models were a regular purchase by corporate militaries and shadow teams that operated far from civilization. Several are still used as mobile search & rescue supply points for the Cascade ork tribe.

Std. Upgrades: Obsolescent, Improved Takeoff and Landing 2, Special Storage

- These are still a lifesaver for long-patrol ops. The ability to re-supply after an incident can make all the difference in whether you succeed in a mission or not.
- Picador
- It is also a nice way to slip needed tools to a team after they have gone through security checkpoint or established their cover identities.
- Fianchetto

- I've used these before to get things across a border without linking myself directly to the shipment.
- Marcos

ARES GUARDIAN (MEDIUM DRONE)

This security drone moves quickly through its assigned areas thanks to its hover movement system. An early part of Ares' Sentinel™ drone program, its limited electronics and modem bandwidth are painfully obvious in the current wireless arena.

Std. Upgrades: Obsolescent, Hovercraft Upgrade, Weapon Mount (turret, external, remote)

- A remote control gun emplacement with a prettier name. They are regularly armed with machine guns, firing the bullet du jour.
- DangerSensei
- They were SOTA seven years ago, but the proliferation of wireless exploits leaves them pretty vulnerable.
- Rigger X

CYBERSPACE DESIGNS WOLFHOUND (MEDIUM DRONE)

This was a top-of-the-line reconnaissance drone less than ten years ago. It is no longer a cutting edge design, although its basic airframe and rapid acceleration still appeal to those riggers that can maintain its older data architecture.

Std. Upgrades: Obsolescent, Adaptability 2 autosoft

- Not really worth updating at this point, the original data bus design is nearly twenty years old, and the manufacturer never replaced it with a better version. It's fine if you like second-rate gear.
- Clockwork

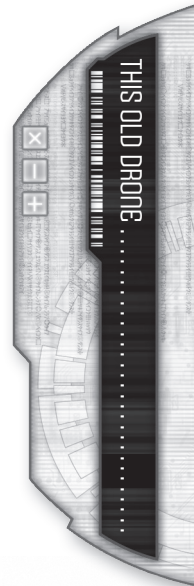

Drones	Handling	Accel	Speed	Pilot	Body	Armor	Sensor	Avail	Cost
Lone Star Strato-9	+2	1/4	100	2	3	1	4	8F	3,500¥
Ares Air-Supply	0	1/5	300	2	6	2	3	8R	8,500¥
Ares Guardian	+1	1/2	60	3	4	8	4	9R	10,000¥
Wolfhound	+1	1/5	210	2	3	1	2	8F	6,000¥



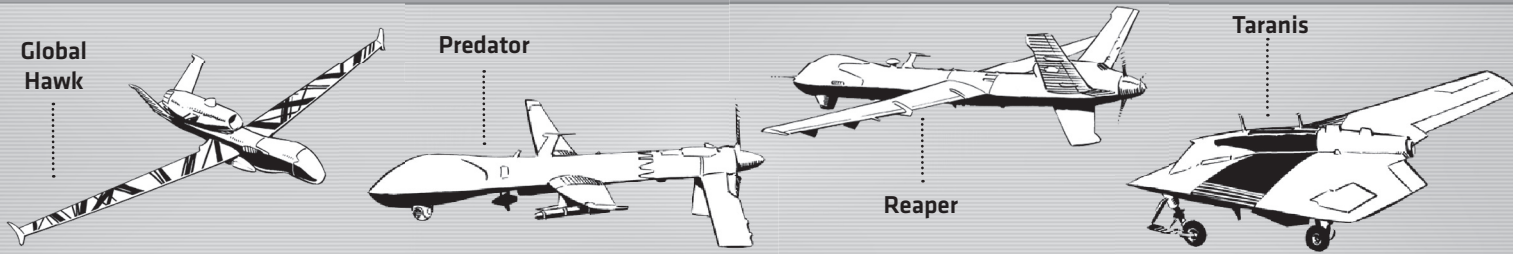

DRONES

RQ-4 GLOBAL HAWK (LARGE DRONE)

This drone was originally built for the United States and allied armed forces. It was a long-range high-altitude reconnaissance drone used to provide tactical and strategic intelligence. It held several records for endurance and altitude until the 2030s. The Crash of 2029 destroyed most of the original control stations, but two are rumored to be operating within former state of Iraq, helping to police the population.

Std. Upgrades: Obsolete, Satellite Communications, Improved Sensor Array, Additional Fuel Tank

- I sometimes manage to pick up feeds from the ones in the Middle East. They seem to fly across the S-K pipelines a lot. No idea what they are looking for, though.
- Rigger X
- I picked up a high-altitude profile similar to one of these dinosaurs near the UCAS/Sioux border. I wonder if someone is peeking across a border they shouldn't?
- Orbital DK

MQ-1 PREDATOR (MEDIUM DRONE)

The Predator was a drone that regularly filled the news vids in the early part of the 21st Century. It was a favorite of militaries worldwide, both for its low cost and for its then-novel armed capability. Today, it is more of a novelty, as its sensors are incapable of competing with current countermeasures and signature reduction technology. They see some use in narco-enforcement, as its thermal sensors can detect unsophisticated operations.

Std. Upgrades: Obsolete, Satellite Communications, 2 Weapon Mounts (external, remote-controlled, fixed), Improved Takeoff and Landing 1

- The Granddaddy of today's combat drones. Too bad it's so far behind the tech curve that nobody would use one when it mattered.
- Clockwork
- Actually there is benefit of near anonymity. When the Predator was originally produced RFID technology wasn't used inside all of its components. Basically, unlike today's technology, these won't tell on themselves.
- Picador

MQ-9 REAPER (LARGE DRONE)

One of the first purpose-built combat drones deployed, the Reaper led a less vigorous life than its smaller brother, the Predator. The Reaper was developed from the Predator to provide strike and close-air support capability without exposing more expensive assets to hostile defenses. The Reaper has largely been removed from national inventories as modern systems provide the same capability with far less expense.

Std. Upgrades: Obsolete, Satellite Communications, 4 Weapon Mounts (external, remote-controlled, fixed), and Additional Fuel Tank

- This would actually still be a decent combat drone if could actually be, well, rigged.
- Clockwork
- Obsolete, hel-/o.
- Netcat

TARANIS MK IV (LARGE DRONE)

This drone was originally intended for the United Kingdom's need for a stealthy penetration bomber and carrier-based strike asset. It had some success in the international arms market but was largely overshadowed by the A-47 series of attack drones. Most of the initial production runs were expended during the Euro Wars, supporting amphibious operations.

Std. Upgrades: Obsolete, Satellite Communications, 2 Weapon Mounts (internal, remote-controlled, fixed), Signature Masking Rtg. 1

- The Lord Protector is rumored to have a nano-forge building these to order, modified into surveillance platforms.
- Icarus
- It would explain the contents of a certain database I happened into.
- Glitch

Drones	Handling	Accel	Speed	Pilot	Body	Armor	Sensor	Avail	Cost
RQ-4 Global Hawk	-2	1/5	650	2	3	0	3	18F	50,000¥
MQ-1 Predator	-2	1/5	200	2	2	0	2	12R	10,000¥
MQ-9 Reaper	-2	1/5	480	2	2	0	2	12F	22,000¥
Taranis Mk IV	-2	4/15	650	3	4	0	3	18F	57,000¥

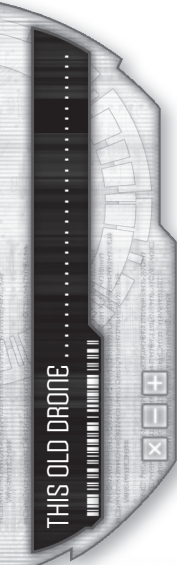

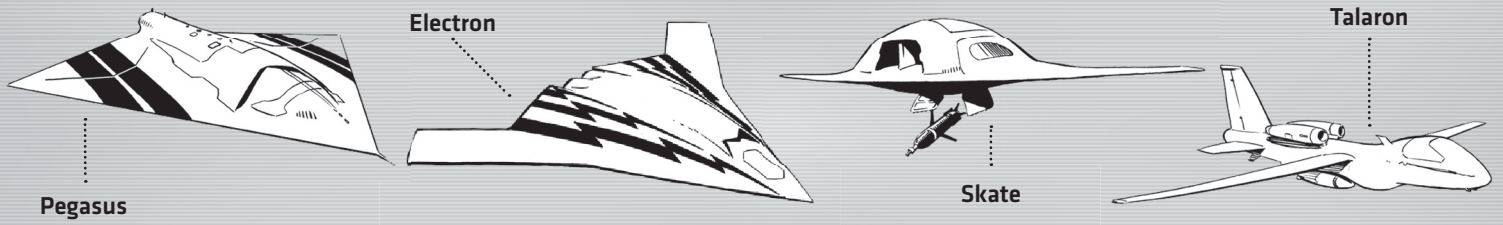

DRONES

A-47D PEGASUS (LARGE DRONE)

This was the first carrier based UCAV fielded by the former United States. It performed first-strike roles that were deemed too dangerous for manned aircraft and long duration surveillance missions. They are still used as aerial targets by the UCAS Air Force to simulate a stealthy intrusion mission profile.

Std. Upgrades: Obsolete, Satellite Communications, Improved Takeoff and Landing 1, 2 Weapon Mounts (internal, remote-controlled, fixed), Signature Masking Rtg. 1

- This thing is an antique and not in a good way. Why would anyone want to use this? The firewall is shit and the stealth can be beaten by a traffic cop.
- Pistons
- Look at the Mil Spec Tech download and see what you can upgrade it into ...
- Rigger X
- Ooh ...
- Pistons
- See, you can never have enough Unicorns.
- Rigger X

MIG SKATE (LARGE DRONE)

This Russian-made drone was one of the country's first major forays into strike-capable unmanned aircraft. There were numerous changes from its initial design in the early 21st century to its production version that was used with effectiveness during the Euro Wars. The Estonian Air Force is largely composed of these aircraft; thirty-year-old relics that the small country cannot afford to replace and can barely manage to repair.

Std. Upgrades: Obsolete, Signature Masking, Rtg. 1, Weapon Mount (internal, remote-controlled, fixed)

- These were often used to perform deep penetration missions against hard targets, resulting in high losses, even with their stealth capabilities.
- Red Anya
- The Estonians aren't the only ones flying them, although I'm not sure that anyone is actually officially making new models.
- Black Mamba

- And this tidbit helps how?
- Slam-O!

DASSAULT ELECTRON (MEDIUM DRONE)

The work of several different aircraft manufacturers, the Electron never seemed to work the way it was intended to. The French found that its stealth features were compromised prior to manufacture. Aztechnology largely stopped production after they purchased Dassault, offering instead to provide a replacement to then-current users. The drone is now found in black markets around the world, forgotten even by the company that made it.

Std. Upgrades: Obsolete, Weapon Mount (internal, remote-controlled, fixed)

- I wouldn't say these are *completely* forgotten. Aztlan was using a few in the Yucatan for recon by fire. More crashed due to the age of the airframe than to hostile fire, but they still fly.
- Marcos

EADS TALARION (LARGE DRONE)

This drone was intended to be a multi-mission platform for the European members of NATO. Its development took too long however, and it finally entered service after NATO dissolved. The Talarion was designed to be a jack-of-all-trades, and it suffered accordingly. Most of the early production was destroyed during the various wars of the 2030s with the remainder purchased by third-world countries after the fighting stopped. Saeder-Krupp still offers maintenance contracts for the surviving drones and also offers substantial trade-in credit towards its more modern offerings.

The Talarion has three additional modification slots available.

Std. Upgrades: Obsolete, Satellite Communications, Additional Fuel Tank

- Why would S-K give up money to recycle bunch of old drones?
- Sunshine
- Because modern designs are all specialized, and they "aren't made the way they used to be". S-K gets to sell more drones that need to be replaced more often. Lofwyr thus creates another market segment.
- Mr. Bonds

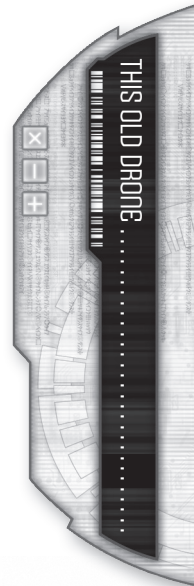

Drones	Handling	Accel	Speed	Pilot	Body	Armor	Sensor	Avail	Cost
A-47D Pegasus	-2	1/4	550	3	4	0	3	16F	51,000¥
MIG Skate	-3	4/15	800	2	4	0	3	20F	48,000¥
Dassault Electron	-2	1/4	1,100	3	3	0	2	16F	62,000¥
EADS Talarion	-2	1/4	720	3	3	0	3	20F	60,000¥



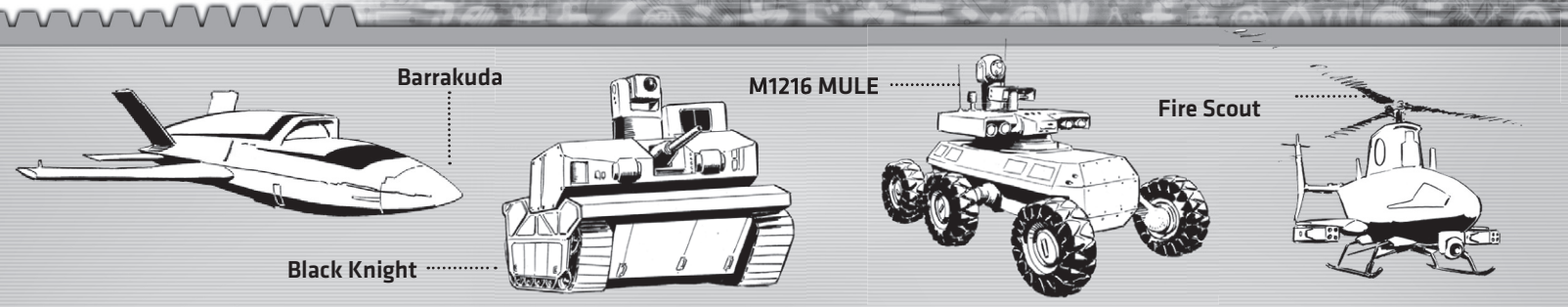

DRONES

EADS BARRAKUDA (LARGE DRONE)

The Barrakuda was the rushed development of a prototype fielded to stop the Islamic Jihad portion of the Euro Wars. The Barrakuda was developed as a strike drone and was extensively fielded to slow the invasion's progress. The unit was initially fielded by MET 2000 but was gradually fielded by several of the European nation's militaries. Saeder-Krupp offers an upgraded control package to current owners, ensuring that the drone can be controlled with current communications protocols.

Std. Upgrades: Obsolete, Satellite Communications, Weapon Mount (internal, remote-controlled, fixed)

- So S-K buys back the Talarion, but not this one. What's the difference?
- Sunshine
- The Barrakuda is basically a cruise missile that can occasionally come back. Once they are launched, most operators plan on just buying a replacement. They might not need as many parts as current designs, but they still need to get replaced once launched.
- Clockwork

BLACK KNIGHT (LARGE DRONE)

The Black Knight was a fire-support vehicle, intended to support infantry and smaller drone units by providing accurate suppression fire against targets identified by the drone's operator. It largely succeeded in its initial design intention, but it lacked the necessary architecture to be upgraded by the cash-strapped militaries of the world. The Black Knight was an early star of the Desert Wars series and continues to be seen on the show's syndicated channel.

Std. Upgrades: Obsolete, Tracked Vehicle

- They still get used in the desert too. Ares runs a few with light auto-cannon as support for defensive positions. They get damaged a lot, but Ares has more every season.
- Black Mamba
- They were a regular contestant in COMBAT DRONE! (c). I miss that show, it was an inspiration.
- Beaker

M1216 MULE

The MULE was a lightweight combat drone fielded by the United States to provide support for Marine units. It was portable enough to be carried by most cargo aircraft and helicopters in inventory at that time. The unit's flexible movement and reasonable cost led to its design being frequently referenced by other manufacturers after the design was mysteriously leaked onto the web in 2024.

Std. Upgrade: Obsolete

- I downloaded the plan from the 'trix, and I can see where certain components were copied, but the overall package is a little primitive.
- Clockwork
- And anyone with a shop can build one, can't they?
- Stone
- I wouldn't say anyone, but they are a lot of fun to send driving around on random streets before they run into a wall.
- Turbo Bunny

MQ-8 FIRE SCOUT

This drone that made the navies what they are today. They still get used by the Carib League as a meager attempt to stop piracy and smuggling. They are also used by some of the pirates as well. The roto-drone features respectable payload and endurance, while carrying enough sensors to pick up older submarines and law enforcement patrols.

Std. Upgrades: Obsolete, Additional Fuel Tank, Improved Sensor Array

- If you can find one updated to accept an AR interface, they make a pretty effective transport for mid-sized loads. Once you have them programmed right, you can set the profile to mimic civilian boats over water. Their range makes them good for remote drop sites, too.
- 2XL
- These are a pain in the ass since they can follow you all day. It's a good thing that jamming their control signal is easy, since it makes their RtB routine kick in. For the record, mine is painted red.
- Kane

Drones	Handling	Accel	Speed	Pilot	Body	Armor	Sensor	Avail	Cost
EADS Barrakuda	-2	1/4	1,040	2	3	0	2	18F	32,000¥
Black Knight	-4	1/4	75	2	14	2	1	20F	40,000¥
M1216 MULE	-3	1/2	40	2	3	1	1	10F	20,000¥
MQ-8 Fire Scout	-3	1/2	200	3	3	0	2	12F	35,000¥

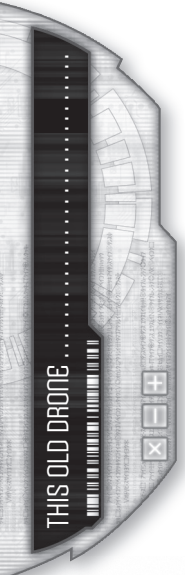

ARES SENTINEL "P" SERIES DRONE

Handl	0	Accel	1/2
Speed	30	Pilot	2
Body	2	Armor	5
Sensor	2	Avail	4R
Cost	1,900¥		

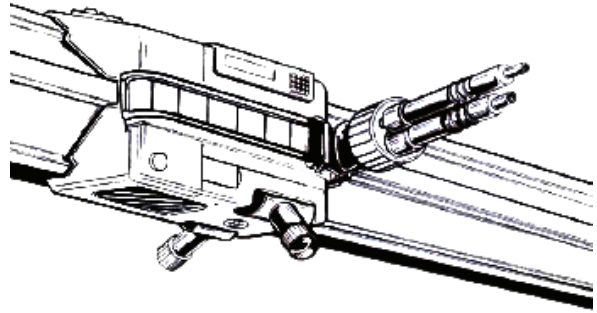

Script 1

Software:

Script 2

Notes:

DRONE DAMAGE

[8 + (BODY÷2)]
BOXES

		-1			-2			-3
		-4			-5			-6

INCOMING FEED.....



FERRET V1

Handl	0	Accel	1/2
Speed	30	Pilot	3
Body	1	Armor	1
Sensor	3	Avail	6
Cost	2,000¥		

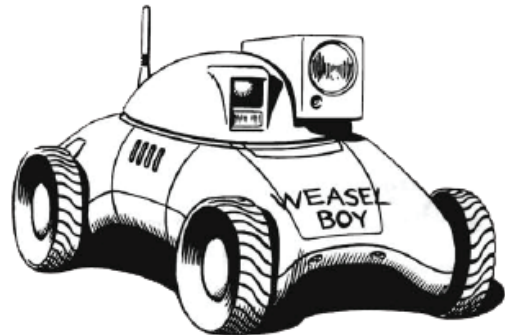

Script 1

Software:

Script 2

Notes:

DRONE DAMAGE

[8 + (BODY÷2)]
BOXES

		-1			-2			-3
		-4			-5			-6

INCOMING FEED.....



AZTECHNOLOGY GCR-65S

Handl	0	Accel	1/3
Speed	60	Pilot	2
Body	1	Armor	0
Sensor	2	Avail	6R
Cost	3,500¥		

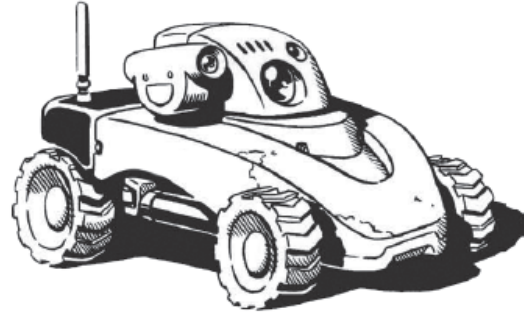

Script 1

Software:

Script 2

Notes:

DRONE DAMAGE

[8 + (BODY+2)]
BOXES

		-1			-2			-3
		-4			-5			-6

INCOMING FEED.....



AZTECHNOLOGY HEDGEHOG

Handl	0	Accel	1/4
Speed	15	Pilot	3
Body	2	Armor	0
Sensor	2	Avail	5R
Cost	3,400¥		

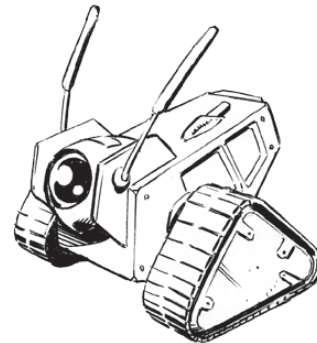

Script 1

Software:

Script 2

Notes:

DRONE DAMAGE

[8 + (BODY+2)]
BOXES

		-1			-2			-3
		-4			-5			-6

INCOMING FEED.....



RENRAKU EVENING MIST

Handl	+1	Accel	1/3
Speed	50	Pilot	2
Body	2	Armor	0
Sensor	1	Avail	4
Cost	1,500¥		



Script 1

Software:

Script 2

Notes:

DRONE DAMAGE

[8 + (BODY÷2)]
BOXES

		-1			-2			-3
		-4			-5			-6

INCOMING FEED.....



YAMATETSU WATCHER 4890

Handl	-1	Accel	1/2
Speed	75	Pilot	1
Body	2	Armor	0
Sensor	2	Avail	6
Cost	1,350¥		

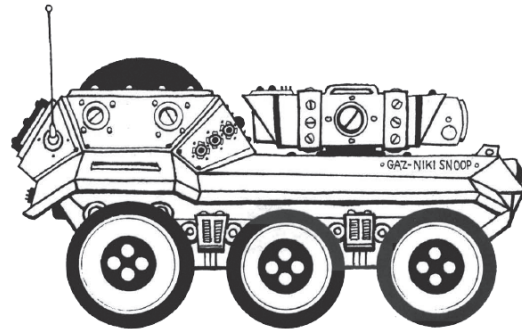

Script 1

Software:

Script 2

Notes:

DRONE DAMAGE

[8 + (BODY÷2)]
BOXES

		-1			-2			-3
		-4			-5			-6

INCOMING FEED.....



MCT HACHIMAN

Handl	-1	Accel	1/3
Speed	30	Pilot	2
Body	4	Armor	8
Sensor	2	Avail	8F
Cost	8,500¥		

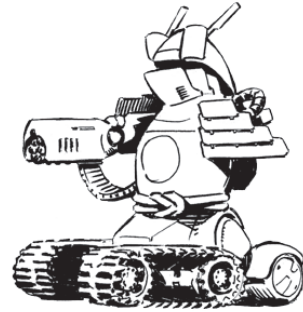

Script 1

Software:

Script 2

Notes:

DRONE DAMAGE

[8 + (BODY÷2)]
BOXES

		-1			-2			-3
		-4			-5			-6

INCOMING FEED.....



LDSD-23

Handl	-4	Accel	1/2
Speed	60	Pilot	1
Body	3	Armor	1
Sensor	2	Avail	4
Cost	5,000¥		

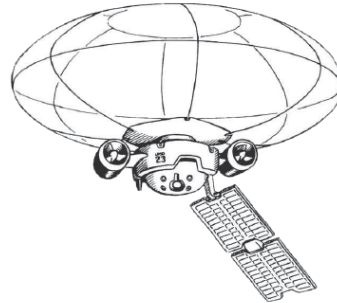

Script 1

Software:

Script 2

Notes:

DRONE DAMAGE

[8 + (BODY÷2)]
BOXES

		-1			-2			-3
		-4			-5			-6

INCOMING FEED.....



LDSD-41

Handl	-3	Accel	1/2
Speed	75	Pilot	3
Body	4	Armor	5
Sensor	2	Avail	4
Cost	7,500¥		

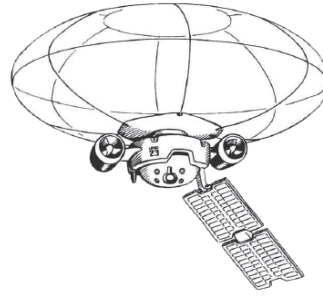

Script 1

Software:

Script 2

Notes:

DRONE DAMAGE

[8 + (BODY+2)]
BOXES

		-1			-2			-3
		-4			-5			-6

INCOMING FEED.....



LIEBRE

Handl	-1	Accel	1/4
Speed	1,620	Pilot	4
Body	4	Armor	4
Sensor	3	Avail	16F
Cost	19,500¥		

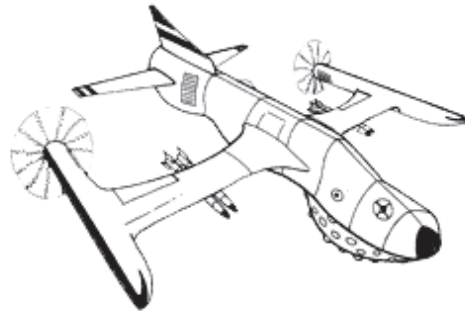

Script 1

Software:

Script 2

Notes:

DRONE DAMAGE

[8 + (BODY+2)]
BOXES

		-1			-2			-3
		-4			-5			-6

INCOMING FEED.....



CAS WANDJINA

Handl	+1	Accel	2/5
Speed	500	Pilot	2
Body	4	Armor	8
Sensor	3	Avail	12F
Cost	12,500¥		

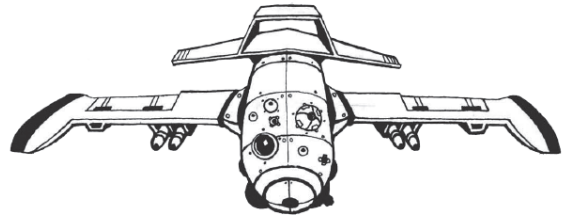

Script 1

Software:

Script 2

Notes:

DRONE DAMAGE

[8 + (BODY÷2)]
BOXES

		-1			-2			-3
		-4			-5			-6

INCOMING FEED.....



EIRRANN-TIR FINSCEAL

Handl	0	Accel	1/3
Speed	105	Pilot	2
Body	3	Armor	1
Sensor	3	Avail	9
Cost	5,500¥		

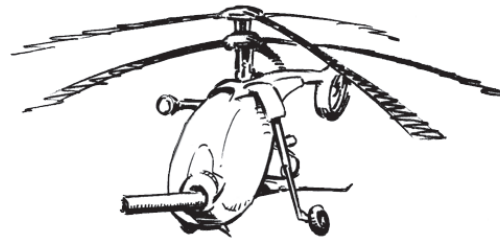

Script 1

Software:

Script 2

Notes:

DRONE DAMAGE

[8 + (BODY÷2)]
BOXES

		-1			-2			-3
		-4			-5			-6

INCOMING FEED.....



LOCKHEED KESTREL

Handl	+1	Accel	1/3
Speed	70	Pilot	2
Body	2	Armor	1
Sensor	2	Avail	8
Cost	1,900¥		

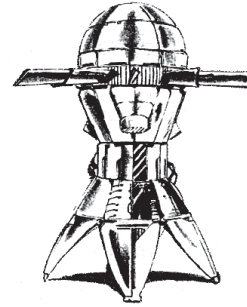

Script 1

Software:

Script 2

Notes:

DRONE DAMAGE

[8 + (BODY+2)]
BOXES

		-1			-2			-3
		-4			-5			-6

INCOMING FEED.....



FED-BOEING COURIER

Handl	0	Accel	1/3
Speed	105	Pilot	2
Body	3	Armor	0
Sensor	2	Avail	6
Cost	6,000¥		

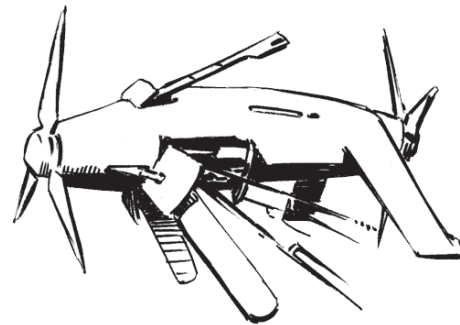

Script 1

Software:

Script 2

Notes:

DRONE DAMAGE

[8 + (BODY+2)]
BOXES

		-1			-2			-3
		-4			-5			-6

INCOMING FEED.....



LONE STAR STRATO-9

Handl	+2	Accel	1/4
Speed	100	Pilot	2
Body	3	Armor	1
Sensor	4	Avail	8F
Cost	3,500¥		

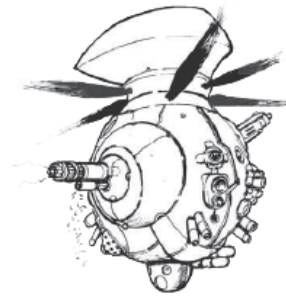

Script 1

Software:

Script 2

Notes:

DRONE DAMAGE

[8 + (BODY+2)]
BOXES

		-1			-2			-3
		-4			-5			-6

INCOMING FEED.....



ARES AIR-SUPPLY

Handl	0	Accel	1/5
Speed	300	Pilot	2
Body	6	Armor	2
Sensor	3	Avail	8R
Cost	8,500¥		

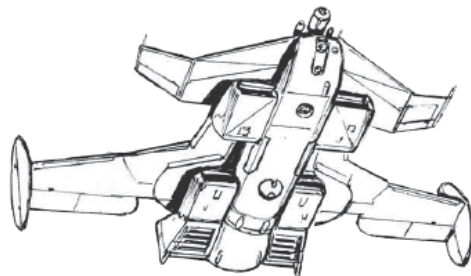

Script 1

Software:

Script 2

Notes:

DRONE DAMAGE

[8 + (BODY+2)]
BOXES

		-1			-2			-3
		-4			-5			-6

INCOMING FEED.....



ARES GUARDIAN

Handl	+1	Accel	1/2
Speed	60	Pilot	3
Body	4	Armor	8
Sensor	4	Avail	9R
Cost	10,000¥		

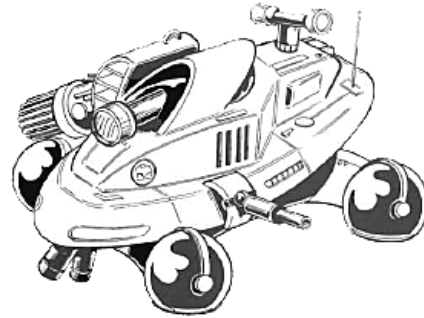

Script 1

Software:

Script 2

Notes:

DRONE DAMAGE

[8 + (BODY+2)]
BOXES

		-1			-2			-3
		-4			-5			-6

INCOMING FEED.....



WOLFHOUND

Handl	+1	Accel	1/5
Speed	210	Pilot	2
Body	3	Armor	1
Sensor	2	Avail	8F
Cost	6,000¥		

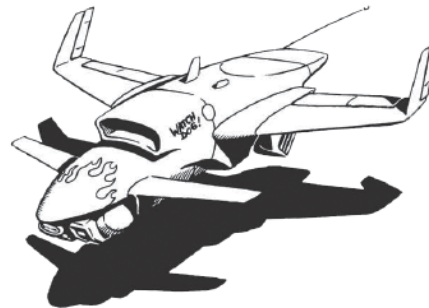

Script 1

Software:

Script 2

Notes:

DRONE DAMAGE

[8 + (BODY+2)]
BOXES

		-1			-2			-3
		-4			-5			-6

INCOMING FEED.....



RQ-4 GLOBAL HAWK

Handl	-2	Accel	1/5
Speed	650	Pilot	2
Body	3	Armor	0
Sensor	3	Avail	18F
Cost	50,000¥		

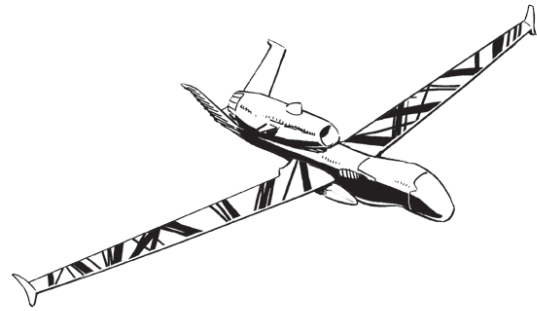

Script 1

Software:

Script 2

Notes:

DRONE DAMAGE

[8 + (BODY+2)]
BOXES

		-1			-2			-3
		-4			-5			-6

INCOMING FEED.....



MQ-1 PREDATOR

Handl	-2	Accel	1/5
Speed	200	Pilot	2
Body	2	Armor	0
Sensor	2	Avail	12R
Cost	10,000¥		

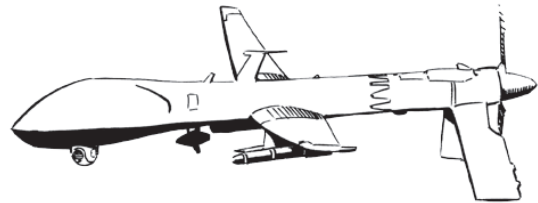

Script 1

Software:

Script 2

Notes:

DRONE DAMAGE

[8 + (BODY+2)]
BOXES

		-1			-2			-3
		-4			-5			-6

INCOMING FEED.....



MQ-9 REAPER

Handl	-2	Accel	1/5
Speed	480	Pilot	2
Body	2	Armor	0
Sensor	2	Avail	12F
Cost	22,000¥		

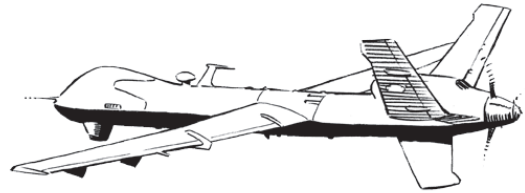

Script 1

Software:

Script 2

Notes:

DRONE DAMAGE

[8 + (BODY+2)]
BOXES

		-1			-2			-3
		-4			-5			-6

INCOMING FEED.....



TARANIS MK IV

Handl	-2	Accel	4/15
Speed	650	Pilot	3
Body	4	Armor	0
Sensor	3	Avail	18F
Cost	57,000¥		

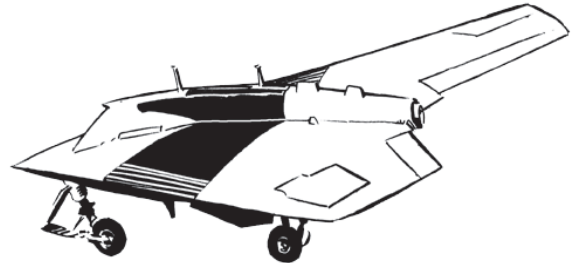

Script 1

Software:

Script 2

Notes:

DRONE DAMAGE

[8 + (BODY+2)]
BOXES

		-1			-2			-3
		-4			-5			-6

INCOMING FEED.....



A-47D PEGASUS

Handl	-2	Accel	1/4
Speed	550	Pilot	3
Body	4	Armor	0
Sensor	3	Avail	16F
Cost	51,000¥		

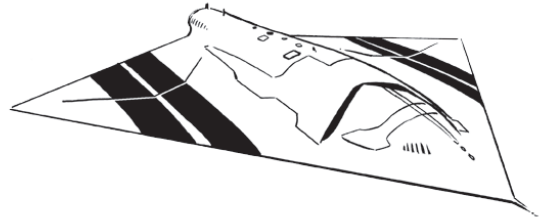

Script 1

Software:

Script 2

Notes:

DRONE DAMAGE

[8 + (BODY+2)]
BOXES

		-1			-2			-3
		-4			-5			-6

INCOMING FEED.....



MIG SKATE

Handl	-3	Accel	4/15
Speed	800	Pilot	2
Body	4	Armor	0
Sensor	3	Avail	20F
Cost	48,000¥		



Script 1

Software:

Script 2

Notes:

DRONE DAMAGE

[8 + (BODY+2)]
BOXES

		-1			-2			-3
		-4			-5			-6

INCOMING FEED.....



DASSAULT ELECTRON

Handl	-2	Accel	1/4
Speed	1,100	Pilot	3
Body	3	Armor	0
Sensor	2	Avail	16F
Cost	62,000¥		

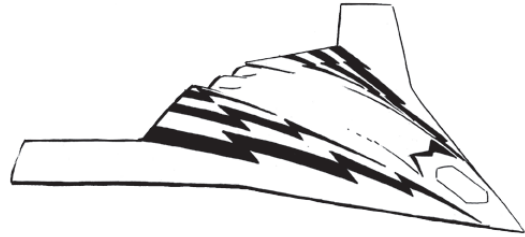

Script 1

Software:

Script 2

Notes:

DRONE DAMAGE

[8 + (BODY+2)]
BOXES

		-1			-2			-3
		-4			-5			-6

INCOMING FEED.....



EADS TALARION

Handl	-2	Accel	1/4
Speed	720	Pilot	3
Body	3	Armor	0
Sensor	3	Avail	20F
Cost	60,000¥		

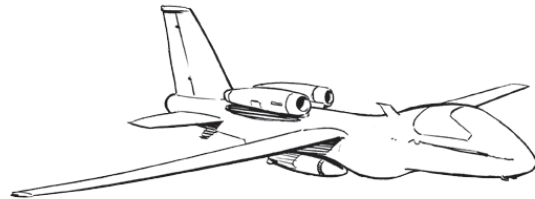

Script 1

Software:

Script 2

Notes:

DRONE DAMAGE

[8 + (BODY+2)]
BOXES

		-1			-2			-3
		-4			-5			-6

INCOMING FEED.....



EADS BARRAKUDA

Handl	-2	Accel	1/4
Speed	1,040	Pilot	2
Body	3	Armor	0
Sensor	2	Avail	18F
Cost	32,000¥		

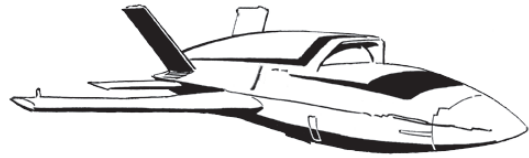

Script 1

Software:

Script 2

Notes:

DRONE DAMAGE

[8 + (BODY+2)]
BOXES

		-1			-2			-3
		-4			-5			-6

INCOMING FEED.....



BLACK KNIGHT

Handl	-4	Accel	1/4
Speed	75	Pilot	2
Body	14	Armor	2
Sensor	1	Avail	20F
Cost	40,000¥		

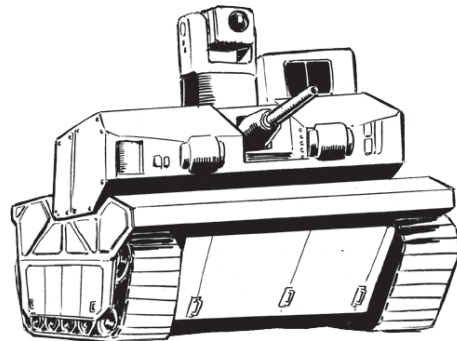

Script 1

Software:

Script 2

Notes:

DRONE DAMAGE

[8 + (BODY+2)]
BOXES

		-1			-2			-3
		-4			-5			-6

INCOMING FEED.....



M1216 MULE

Handl	-3	Accel	1/2
Speed	40	Pilot	2
Body	3	Armor	1
Sensor	1	Avail	10F
Cost	20,000¥		

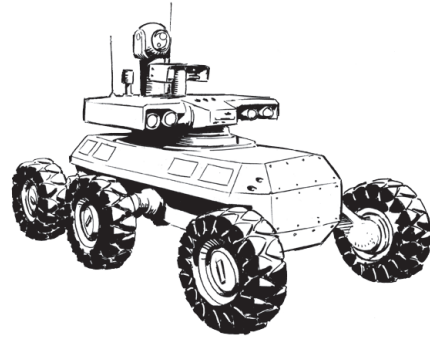

Script 1

Software:

Script 2

Notes:

DRONE DAMAGE

[8 + (BODY+2)]
BOXES

		-1			-2			-3
		-4			-5			-6

INCOMING FEED.....



MQ-8 FIRE SCOUT

Handl	-3	Accel	1/2
Speed	200	Pilot	3
Body	3	Armor	0
Sensor	2	Avail	12F
Cost	35,000¥		



Script 1

Software:

Script 2

Notes:

DRONE DAMAGE

[8 + (BODY+2)]
BOXES

		-1			-2			-3
		-4			-5			-6

INCOMING FEED.....

